

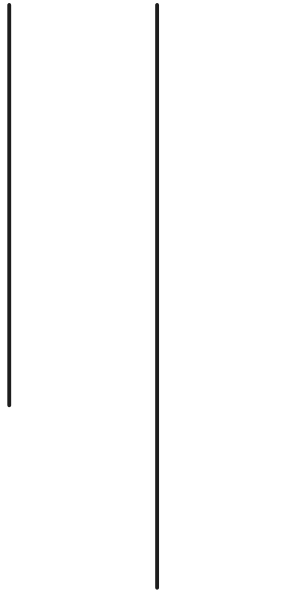

RAUTAMAI RURAL MUNICIPALITY  
OFFICE OF THE RURAL MUNICIPAL  
BHUTTAR UDAYAPUR  
PROVINCE NO 1



PROJECT : CONSTRUCTION OF WARD LEVEL  
HEALTH CARE CENTER

LOCATION : RAUTAMAI RURAL MUNICIPALITY

FISCAL YEAR : 2075/076



RAUTAMAI RURAL MUNICIPALITY  
OFFICE OF THE RURAL MUNICIPAL  
BHUTTAR UDAYAPUR  
PROVINCE NO 1

PROJECT : CONSTRUCTION OF WARD  
LEVEL HEALTH CARE CENTER

LOCATION : RAUTAMAI RURAL  
MUNICIPALITY

PREPARED BY :

CHECKED BY :

APPROVED BY :

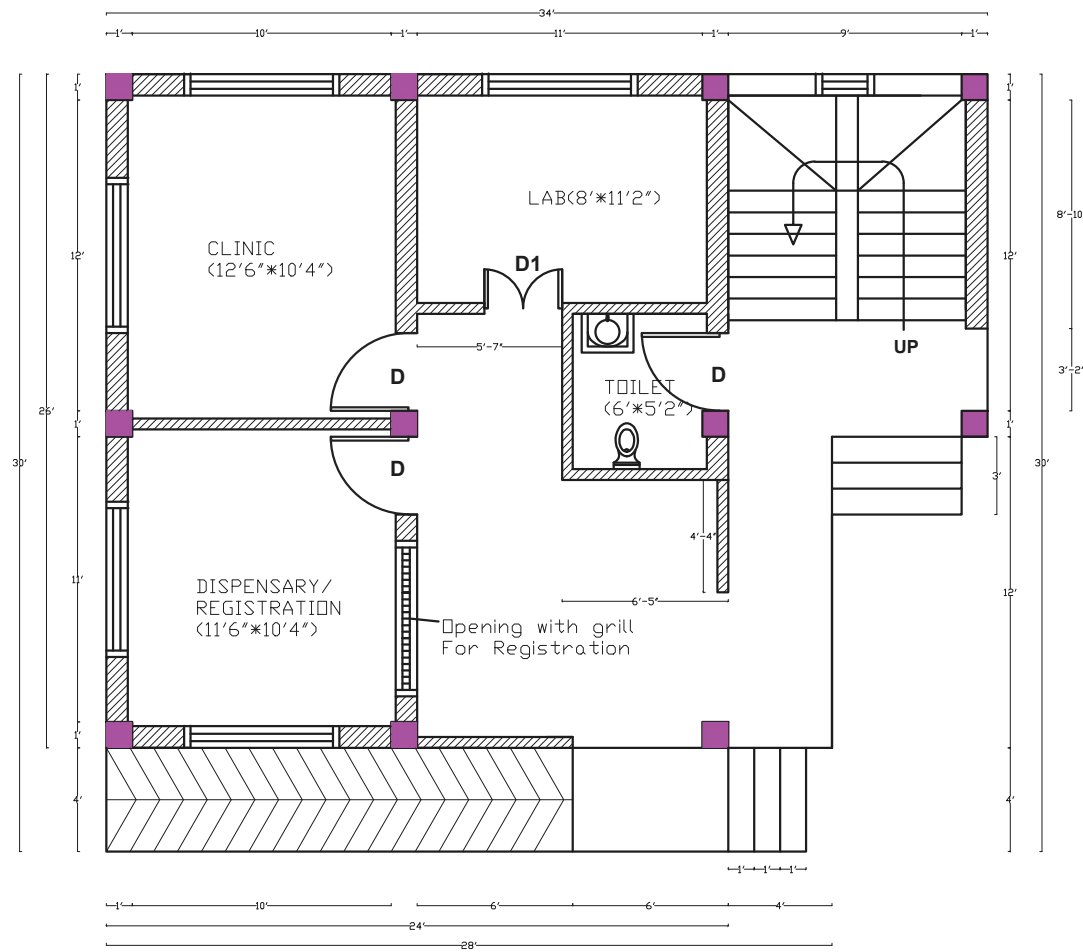

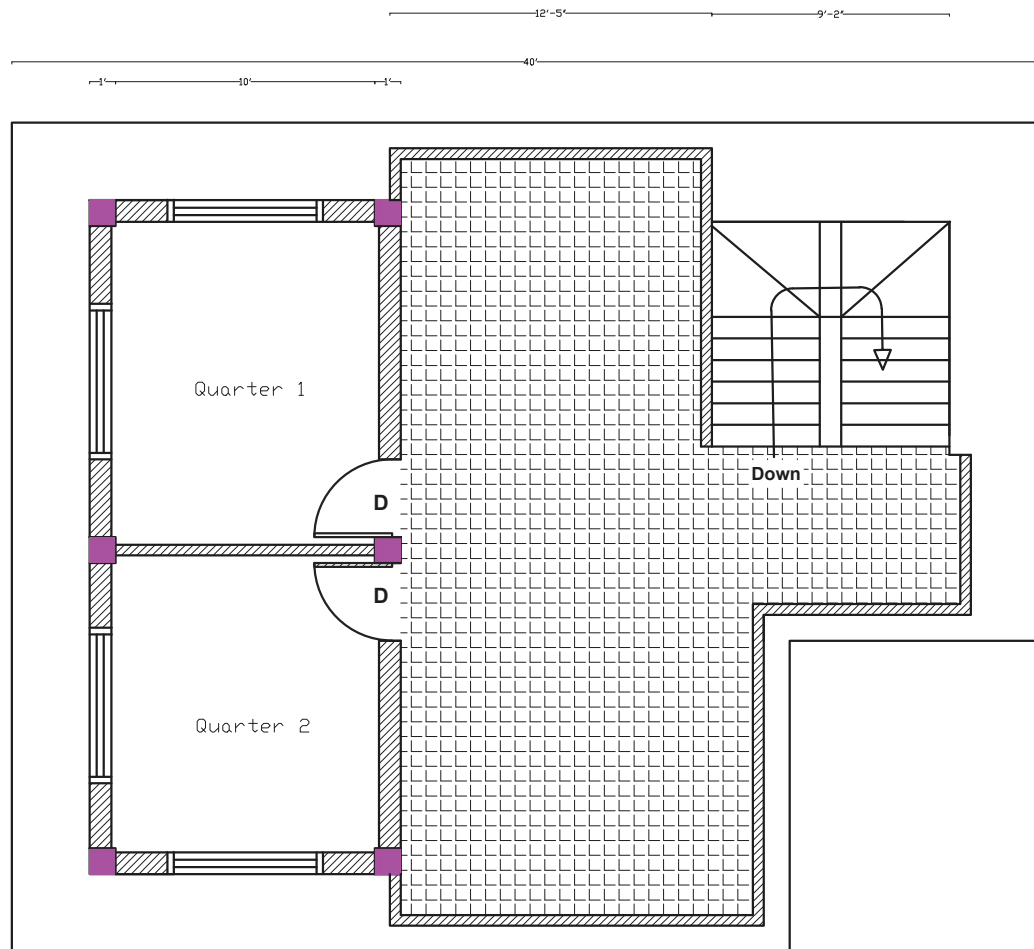

First Floor Plan View



RAUTAMAI RURAL MUNICIPALITY  
 OFFICE OF THE RURAL MUNICIPAL  
 BHUTTAR UDAYAPUR  
 PROVINCE NO 1

PROJECT : CONSTRUCTION OF WARD  
 LEVEL HEALTH CARE CENTER

LOCATION : RAUTAMAI RURAL  
 MUNICIPALITY

PREPARED BY :

CHECKED BY :

APPROVED BY :



RAUTAMAI RURAL MUNICIPALITY  
OFFICE OF THE RURAL MUNICIPAL  
BHUTTAR UDAYAPUR  
PROVINCE NO 1

PROJECT : CONSTRUCTION OF WARD  
LEVEL HEALTH CARE CENTER

LOCATION : RAUTAMAI RURAL  
MUNICIPALITY

PREPARED BY :

CHECKED BY :

APPROVED BY :



Front Side View



RAUTAMAI RURAL MUNICIPALITY  
OFFICE OF THE RURAL MUNICIPAL  
BHUTTAR UDAYAPUR  
PROVINCE NO 1

PROJECT : CONSTRUCTION OF WARD  
LEVEL HEALTH CARE CENTER

LOCATION : RAUTAMAI RURAL  
MUNICIPALITY

PREPARED BY :

CHECKED BY :

APPROVED BY :

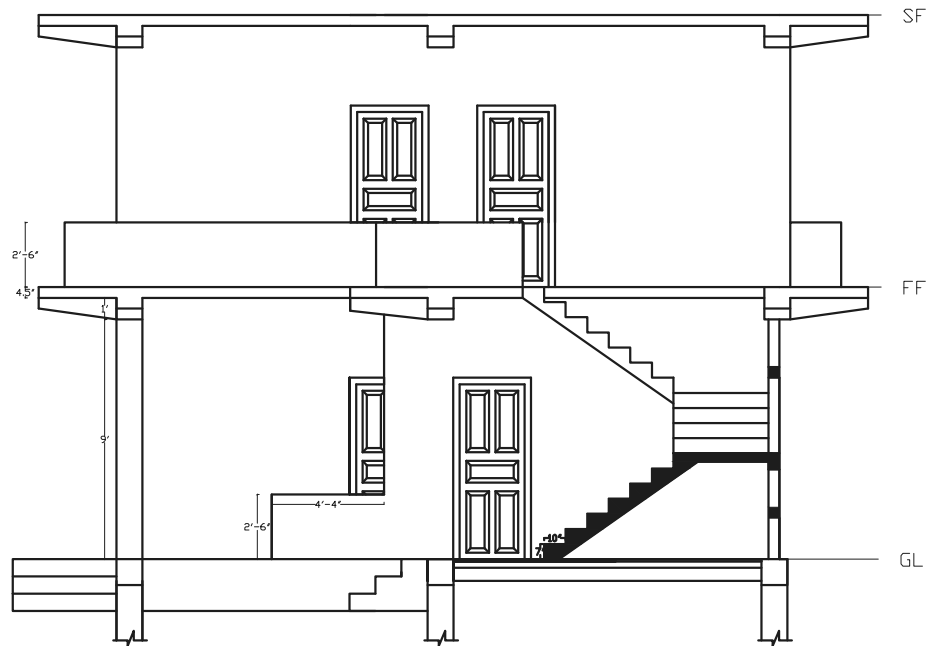

Left side View



RAUTAMAI RURAL MUNICIPALITY  
OFFICE OF THE RURAL MUNICIPAL  
BHUTTAR UDAYAPUR  
PROVINCE NO 1

PROJECT : CONSTRUCTION OF WARD  
LEVEL HEALTH CARE CENTER

LOCATION : RAUTAMAI RURAL  
MUNICIPALITY

PREPARED BY :

CHECKED BY :

APPROVED BY :

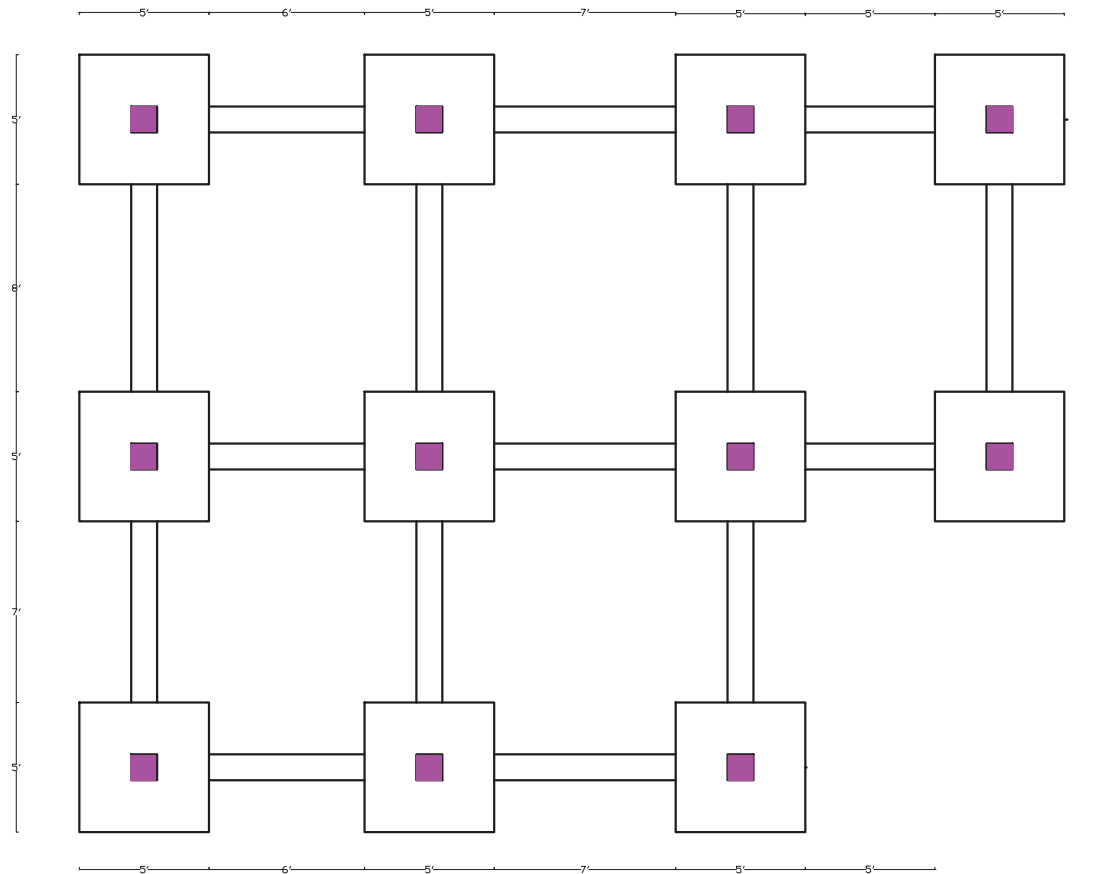

Trench Plan View



RAUTAMAI RURAL MUNICIPALITY  
OFFICE OF THE RURAL MUNICIPAL  
BHUTTAR UDAYAPUR  
PROVINCE NO 1

PROJECT : CONSTRUCTION OF WARD  
LEVEL HEALTH CARE CENTER

LOCATION : RAUTAMAI RURAL  
MUNICIPALITY

PREPARED BY :

CHECKED BY :

APPROVED BY :

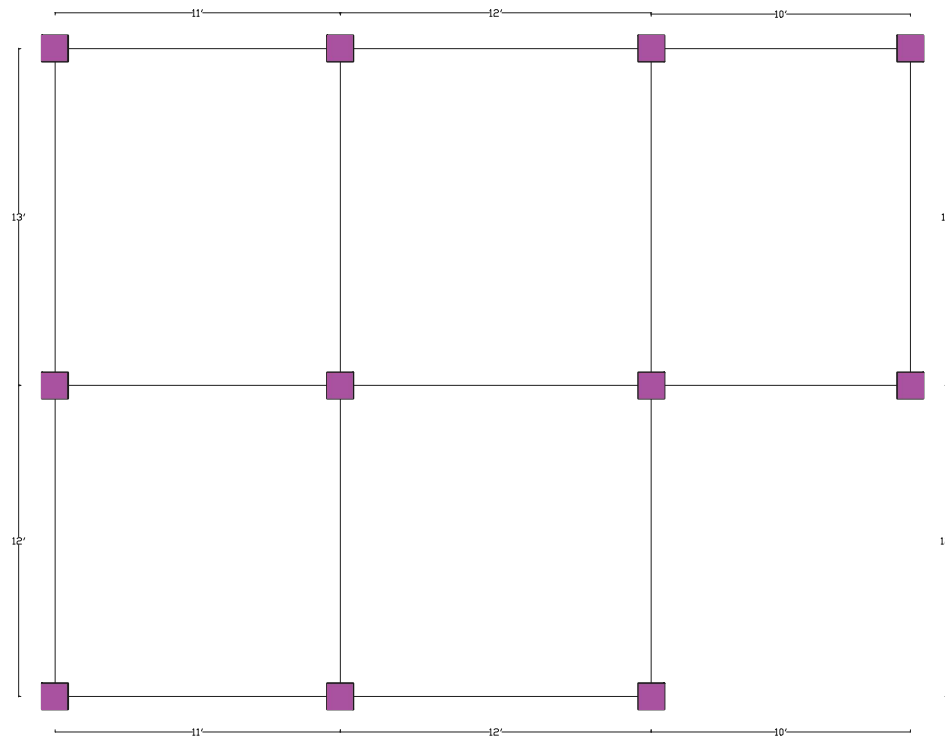

Column Plan View



RAUTAMAI RURAL MUNICIPALITY  
OFFICE OF THE RURAL MUNICIPAL  
BHUTTAR UDAYAPUR  
PROVINCE NO 1

PROJECT : CONSTRUCTION OF WARD  
LEVEL HEALTH CARE CENTER

LOCATION : RAUTAMAI RURAL  
MUNICIPALITY

PREPARED BY :

CHECKED BY :

APPROVED BY :

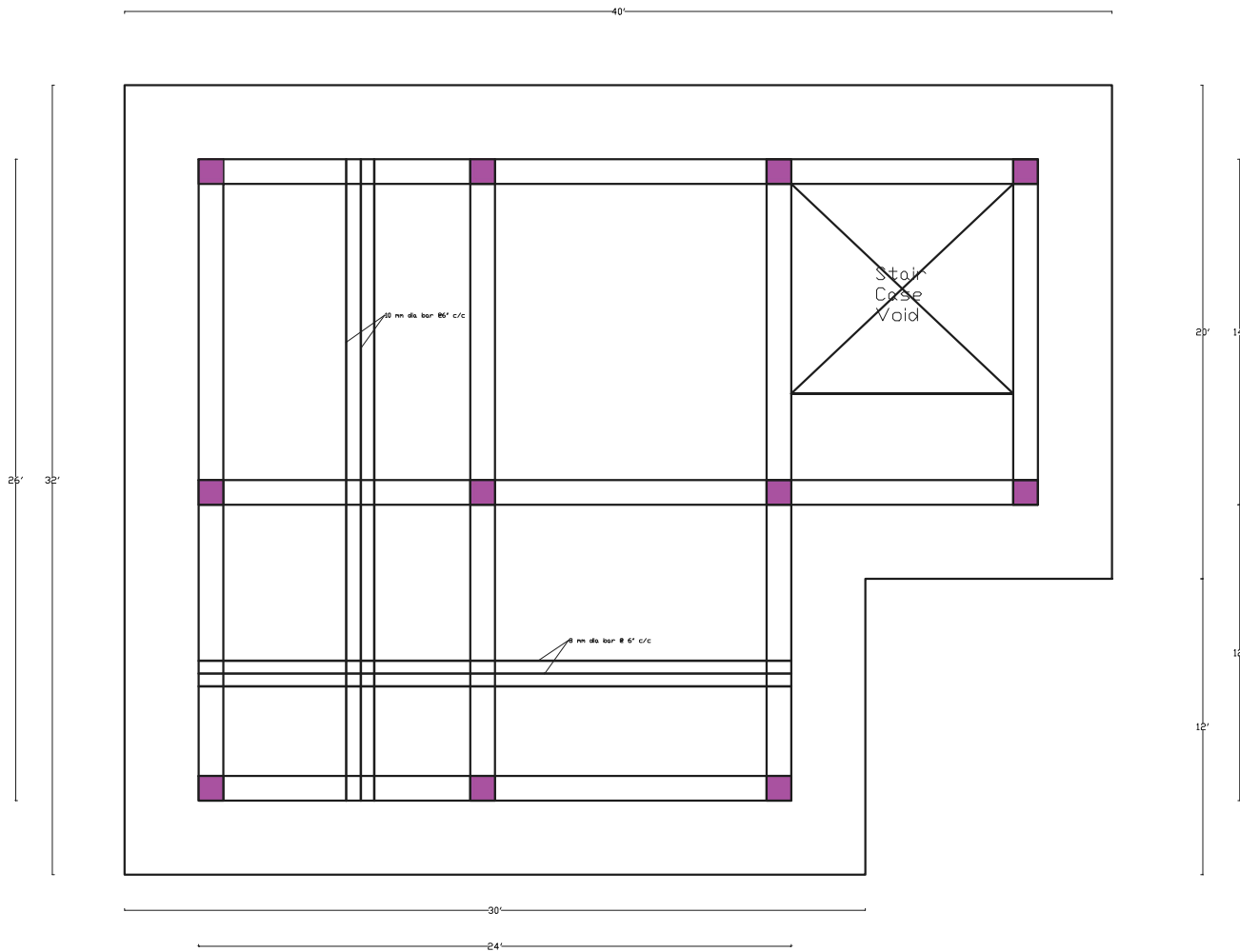

First Floor Bottom Reinforcement





RAUTAMAI RURAL MUNICIPALITY  
OFFICE OF THE RURAL MUNICIPAL  
BHUTTAR UDAYAPUR  
PROVINCE NO 1

PROJECT : CONSTRUCTION OF WARD  
LEVEL HEALTH CARE CENTER

LOCATION : RAUTAMAI RURAL  
MUNICIPALITY

PREPARED BY :

CHECKED BY :

APPROVED BY :

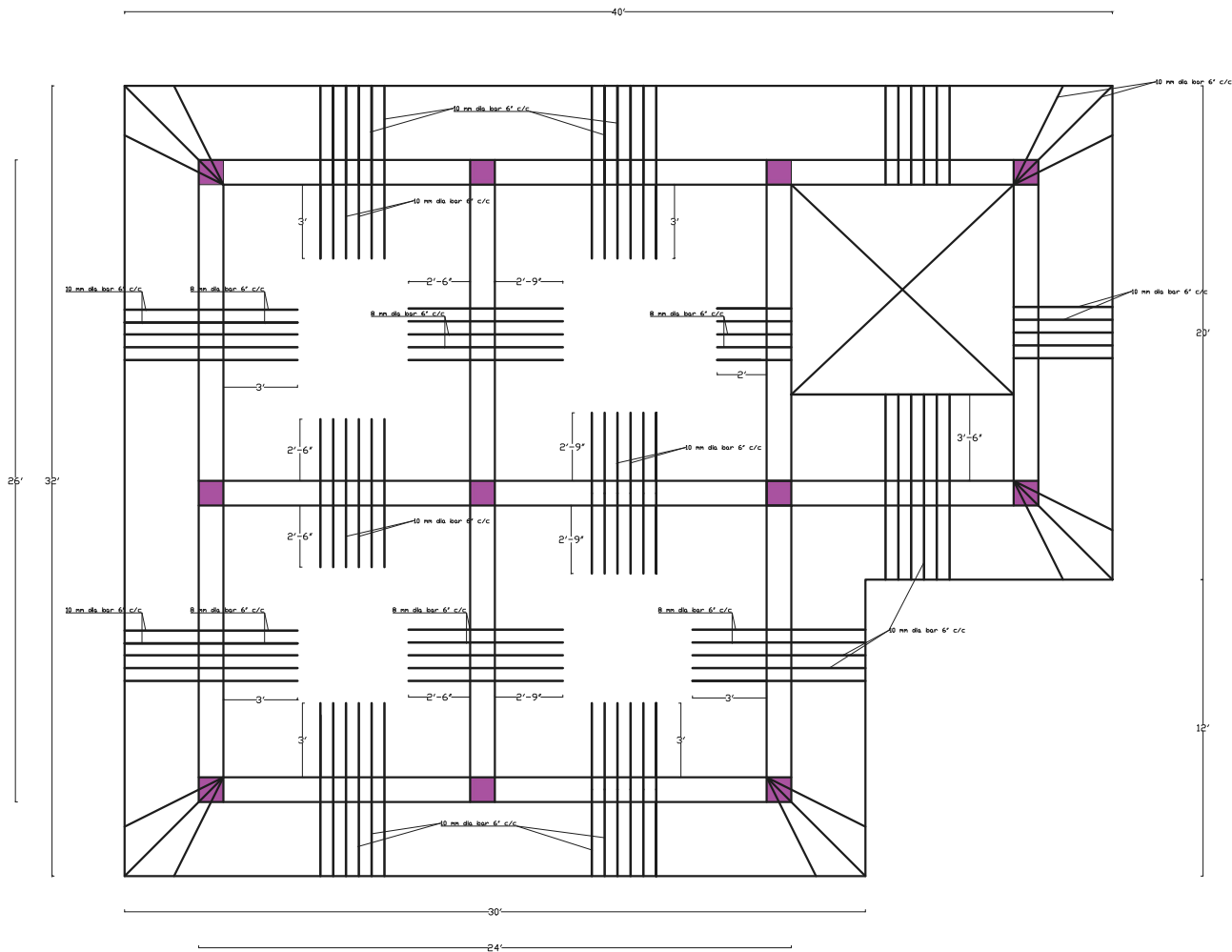

First Floor Top Reinforcement

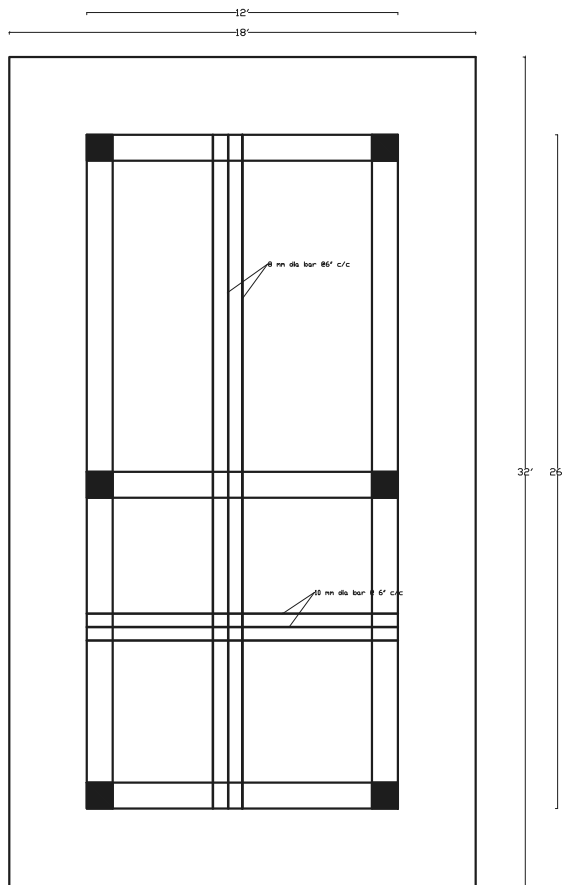

Roof Slab Bottom Reinforcement



RAUTAMAI RURAL MUNICIPALITY  
OFFICE OF THE RURAL MUNICIPAL  
BHUTTAR UDAYAPUR  
PROVINCE NO 1

PROJECT : CONSTRUCTION OF WARD  
LEVEL HEALTH CARE CENTER

LOCATION : RAUTAMAI RURAL  
MUNICIPALITY

PREPARED BY :

CHECKED BY :

APPROVED BY :



RAUTAMAI RURAL MUNICIPALITY  
OFFICE OF THE RURAL MUNICIPAL  
BHUTTAR UDAYAPUR  
PROVINCE NO 1

PROJECT : CONSTRUCTION OF WARD  
LEVEL HEALTH CARE CENTER

LOCATION : RAUTAMAI RURAL  
MUNICIPALITY

PREPARED BY :

CHECKED BY :

APPROVED BY :

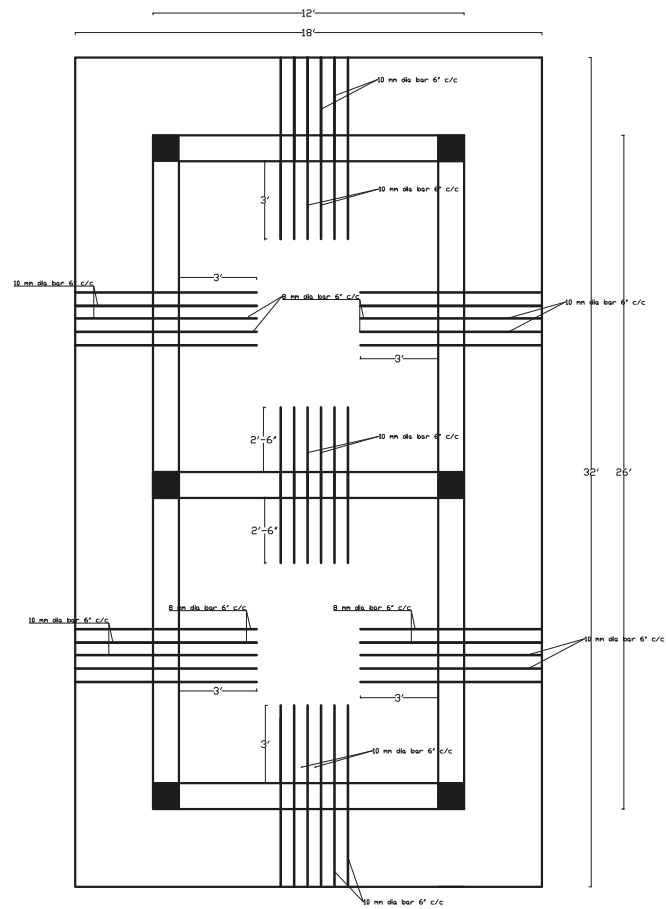

Roof Slab Top Reinforcement



RAUTAMAI RURAL MUNICIPALITY  
OFFICE OF THE RURAL MUNICIPAL  
BHUTTAR UDAYAPUR  
PROVINCE NO 1

PROJECT : CONSTRUCTION OF WARD  
LEVEL HEALTH CARE CENTER

LOCATION : RAUTAMAI RURAL  
MUNICIPALITY

PREPARED BY :

CHECKED BY :

APPROVED BY :

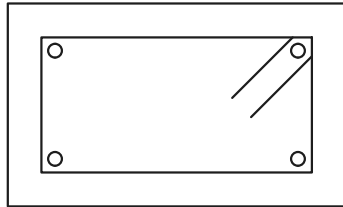

6" Thick  
Lintel  
Band, 4 no  
of 12 mm  
dia bar, 8  
mm dia  
stirrups  
@4"c/c

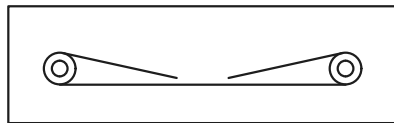

3" Thick  
Sill Band, 2  
no of 10  
mm dia  
bar, 8 mm  
dia  
stirrups  
@4"c/c

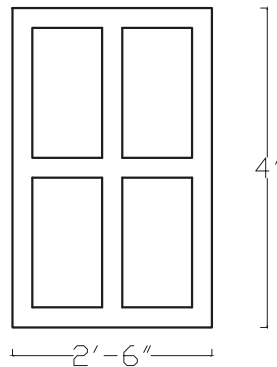

Ventilation for Stair case

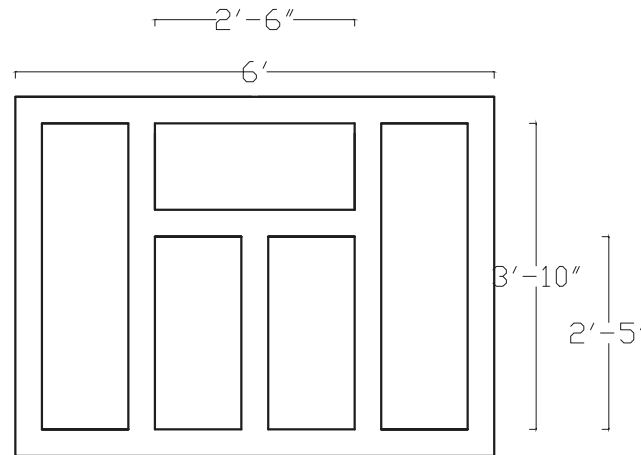

Window Chaukat/Frame

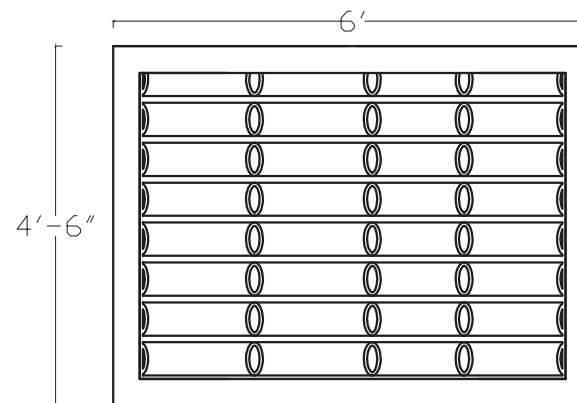

Opening For Registration Room



RAUTAMAI RURAL MUNICIPALITY  
OFFICE OF THE RURAL MUNICIPAL  
BHUTTAR UDAYAPUR  
PROVINCE NO 1

PROJECT : CONSTRUCTION OF WARD  
LEVEL HEALTH CARE CENTER

LOCATION : RAUTAMAI RURAL  
MUNICIPALITY

PREPARED BY :

CHECKED BY :

APPROVED BY :

